

Socket connectors 2.00mm

Single row/double row

Solder tail



深圳平志电子有限公司
SHENZHEN PIZCONN ELECTRONIC CO.,LTD

TEL:86-755-84106483 61121902

FAX:86-755-61121902

E-mail:ivan@pizconn.com.cn

Ordering information

TSA2 - NNN X - A P P 0940A

No. of Positions	Insulator Type code	Pin Plating code	Clip Plating code
	1 Single row	1 Tin150μ"	1 Tin150μ"
	2 Double row	2 Tin200μ"	2 Tin200μ"
		3 GF	3 GF
		4 Gold2μ"	4 Gold2μ"
		5 Gold3μ"	5 Gold3μ"
		6 Gold10μ"	6 Gold10μ"
		7 Gold15μ"	7 Gold15μ"
		S Special	S Special

Series: TSA2

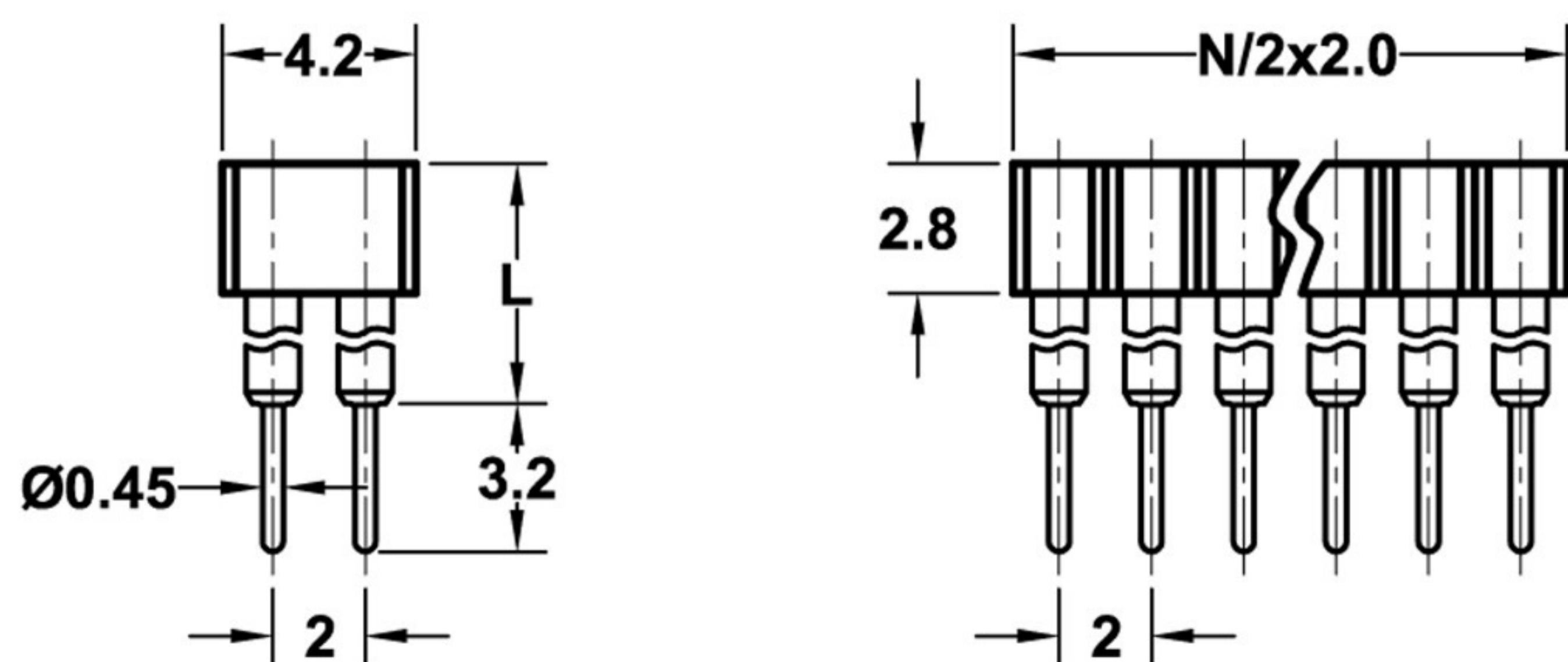
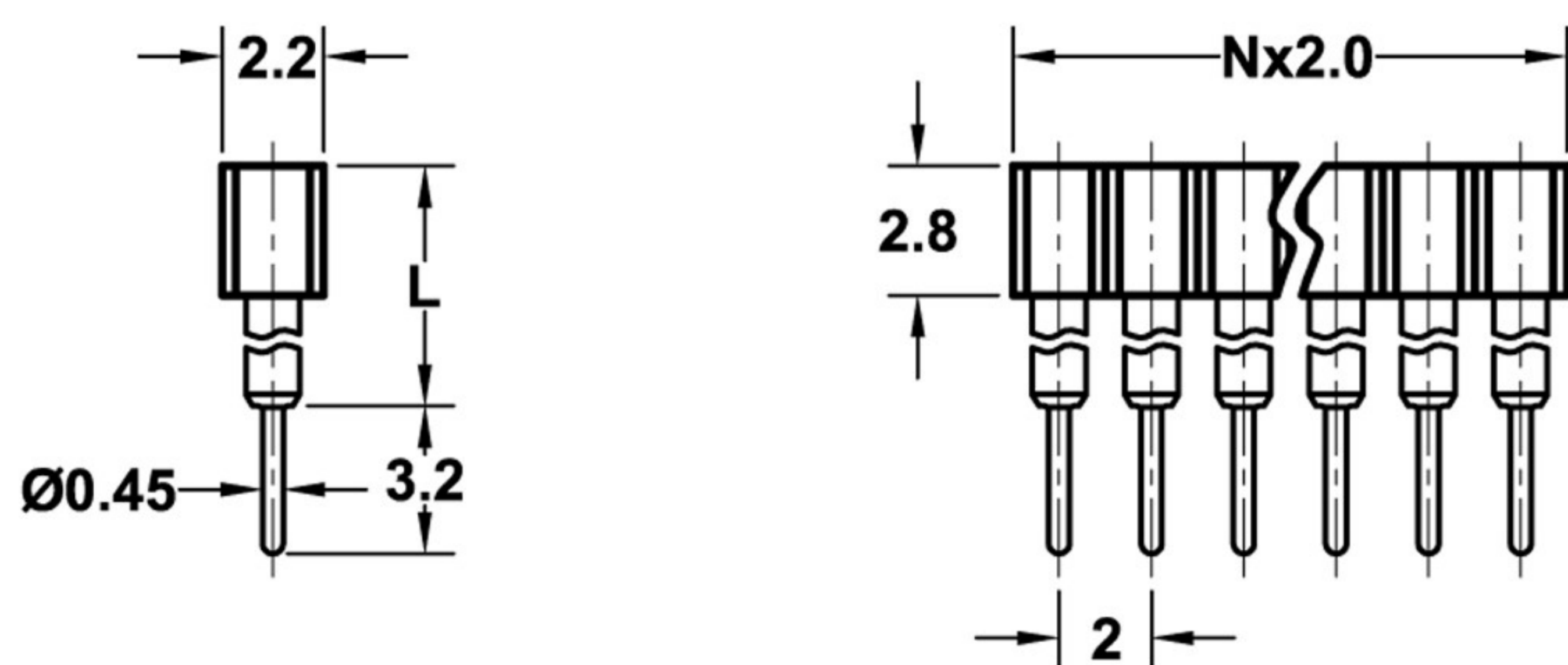
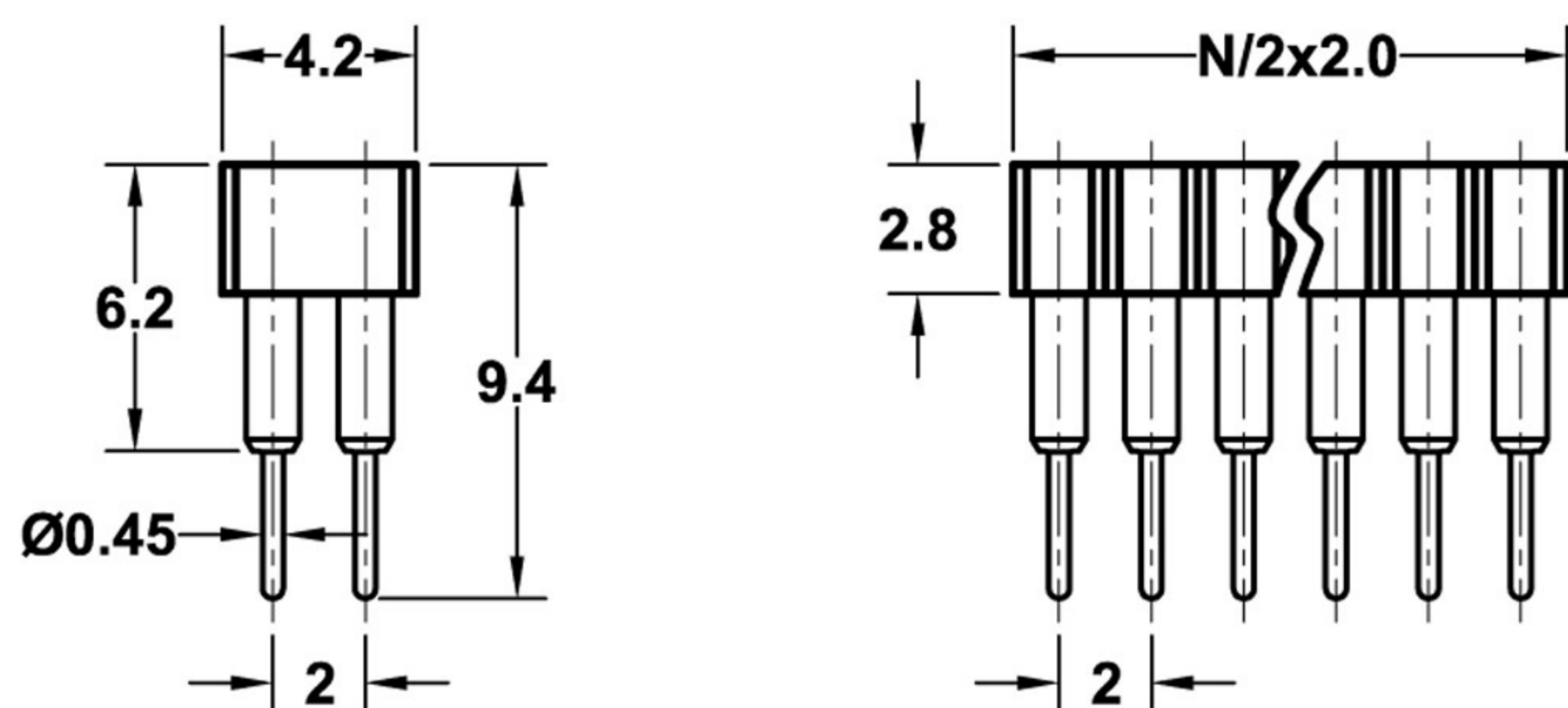
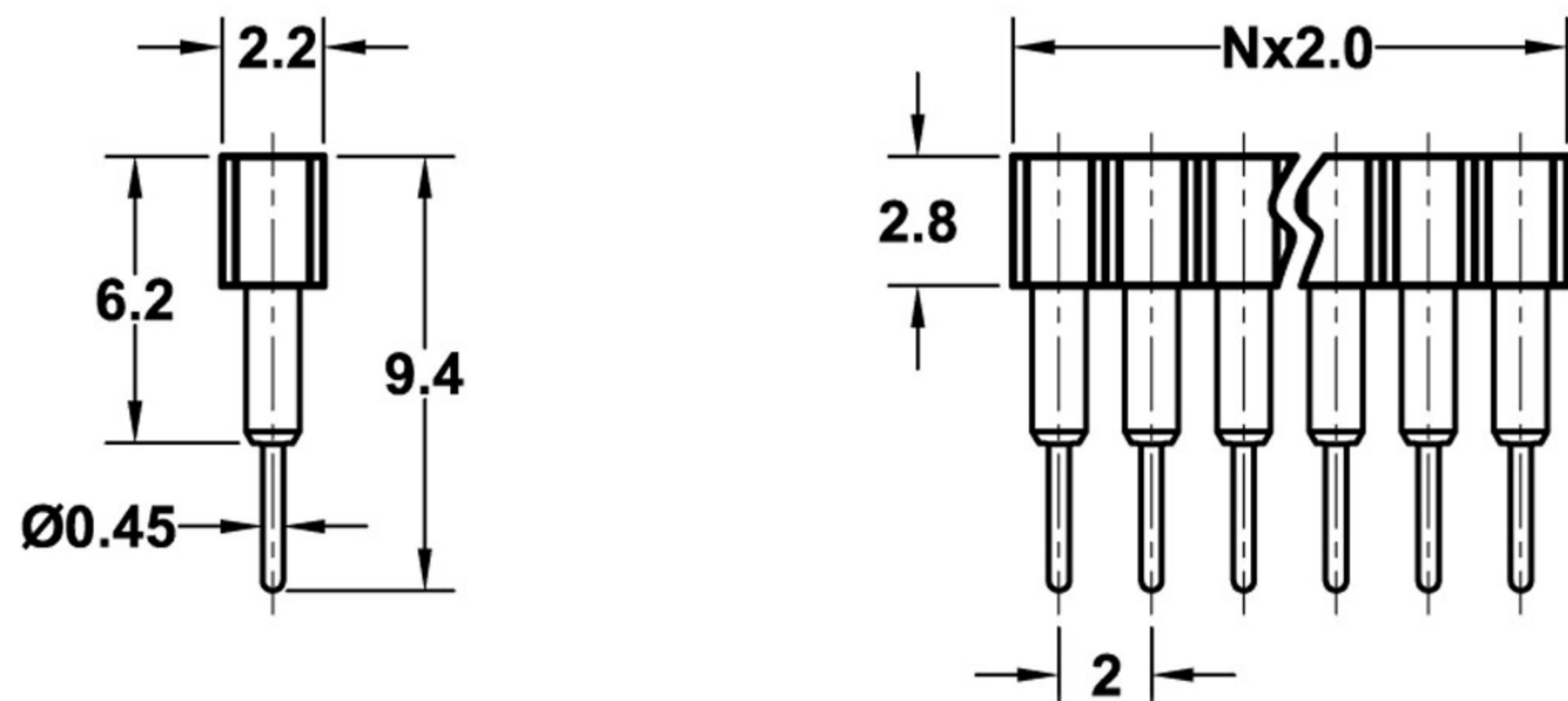
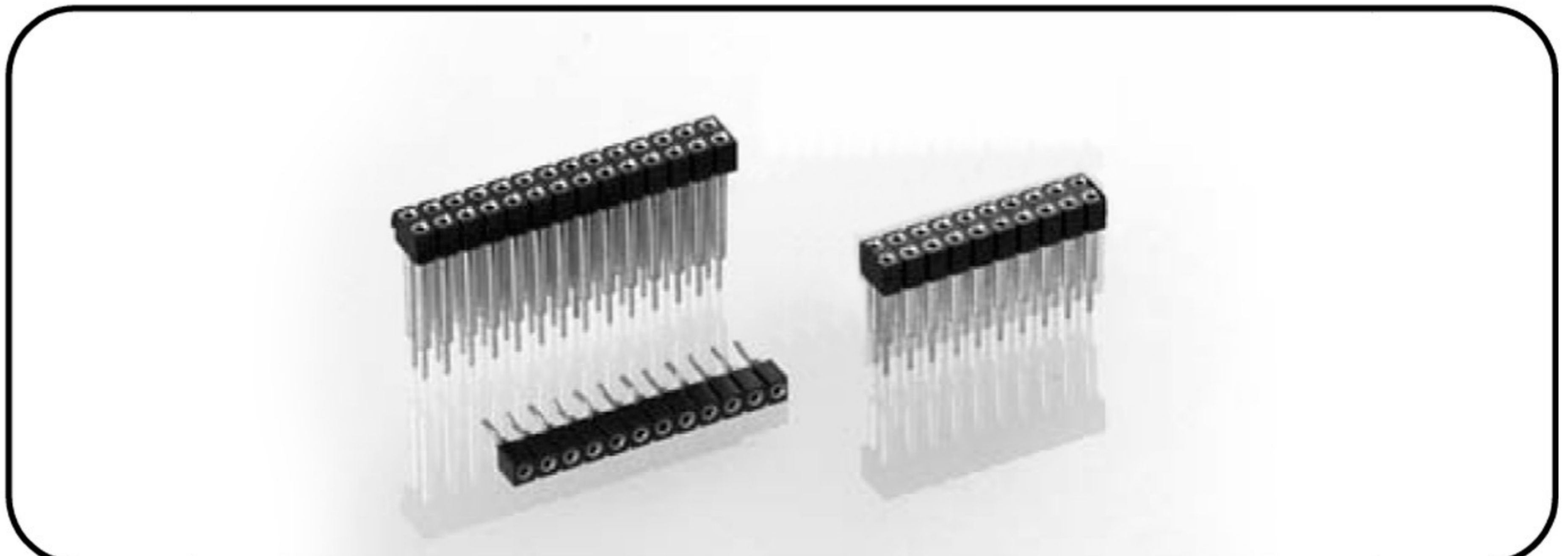

"Hard metric" PCB Socket connectors, Solder tail

Technical Specs:

Insulator:	Black glass filled polyester PPS-GF30-FR
Flammability:	UL 94V-O
Sleeve:	Brass CuZn 36pb3(36000)
Contact clip (6 finger):	Beryllium copper (C17200)
Mating pin Ø:	0.40 to 0.66 mm or 0.50SQ
Forces:	(polished steel gauge Ø 0.46mm)
-Insertion	0.7 N typ.
-Withdrawal	0.4 N typ.
Mechanical life:	min 500 cycles
Rated current:	3 A
Contact resistance:	max 10 mΩ
Dielectric strength:	min 1000V _{RMS}